

# BevFlex-4X Low Noise Receiving Antenna Installation Manual

*Rev 2.24 July 2020*



**Unified Microsystems**

**PO Box 133**

**Slinger, WI 53086**

<https://www.unifiedmicro.com/bevflex4x.html>

## **BevFlex-4X System Description and Performance Guidelines**

The Unified Microsystems BevFlex-4X is an upgraded version of the BevPro-1 and BevFlex-4 Beverage antenna systems now in use worldwide for weak signal, low noise reception. This product retains ALL of the features of the original BevPro/BevFlex series while adding the flexibility to accommodate a total of five different antenna systems where the installation of a classic, above ground, Beverage is impractical due to space constraints. A key feature of the BevFlex-4X system is the ability to install ANY of these four antennas using the SAME components included with the BevFlex-4X kit. Descriptions for each antenna configuration follow.

**Figure-1 Components in BevFlex-4X Kit**



**Included Items in BevFlex-4X Kit**

QTY	Description
2	Antenna End Terminator Units
1	Antenna Feed Unit
1	BevFlex-4X Switch Unit
1	BevFlex-4X Quick Start Guide

## **1. Getting Started**

The BevFlex-4X is a versatile system that can be used to build five types of low band, low noise, receive only antennas. This manual has a separate section for each type. You should read the first part, Classic Beverage System, first regardless of

which antenna type you plan to install. That section covers the basic component operation and installation instructions that apply to all antenna configurations.

## **2. Classic Beverage system**

The Beverage receiving antenna was invented by Harold H. Beverage in 1921 and is a proven performer for receiving weak DX signals in the presence of atmospheric and man-made noise. The Beverage antenna is not suitable for transmitting since its overall relative gain is typically 10dB or more lower than a dipole antenna. You may ask why a receiving antenna with such low overall gain is useful as a receiving antenna. The answer lies in the fact that the noise levels on the long wave, medium wave, and lower HF bands are far above the sensitivity of modern receivers. While the overall gain of the Beverage receiving antenna is much lower than most transmit/receive antennas, the signal to noise ratio of signals received in the favored direction of the Beverage antenna will be typically significantly higher than on the main, transmit/receive antenna. The physics behind the antenna design itself are well documented and well understood. You will find many reference articles on-line that fully describe a wide range of creative implementations of Beverage antenna designs ranging from simple to complex.

The performance of the BevFlex-4X Beverage antenna system will be as good as or better than conventional Beverage system installations of the same height and length. The BevFlex-4X design uses RG-6 coaxial cable that is inherently easier to install and more stable than reversible systems employing “open wire”, “window/ladder line”, or “twisted pair wire”. The BevFlex-4X provides increased performance and ease of adjustment in real world installations. The basic Beverage antenna consists of a wire antenna element, a terminating resistance at the far end, and a feed system to bring the signal back to the receiver. Reversible Beverage systems provide the additional feature of switching the termination and feed ends of the antenna system to provide bi-directional performance.

The BevFlex-4X uses a common mode, receiving antenna, wire element, consisting of the outer shield of the RG-6 coaxial cable that extends to each end point of the antenna. The outer shield of the coaxial cable is continuously connected regardless of where the unique feed system is placed along the entire length of the antenna. The terminating resistances to correctly match the impedance ( $Z_0$ ) of the antenna at each end point are replaced with precision reflection components to couple the signals from each end as differential signals inside the coax between the center conductor and shield of the coaxial cable. The center conductor of the coaxial cable can be separated at any point along the entire antenna element length where these differential signals from each end are then brought to the receiver location via the feed point coupling unit to two individual, coaxial feed cables. Regardless of where the feed point is installed along the antenna, the entire length of the antenna is always utilized. The coaxial cable used as the antenna wire simultaneously operates as a common mode antenna and as a differential mode transmission line to bring the signal back from the one end of the antenna while also providing the correct terminating resistance to the other end of the antenna. At the receive location, a switching and impedance matching system is employed to reflect the correct terminating resistance value back to each end of the antenna via the inner conductor of the coaxial cable. While all this sounds simple, it has taken years of prototyping and testing by W8GNM, WC4X, and W9XT with precision test equipment to get the various components designed and developed to the point where a product can be manufactured in quantity to get predictable results.

The exact performance of any given beverage antenna system is dependent on many variables, such as ground conductivity and mounting height above ground, but the most common variable under the control of the operator is the overall antenna length. The following chart in Table-1 can be used as a general guideline to aid in typical installation decisions. The bulk of field experience with the BevFlex-4X design has been with systems ranging from 270 ft. to 800 ft. in length, but testing with antennas as short as 150 ft. in length has yielded encouraging results, especially for the 40 meters to 15 meter bands. Figure-2 shows a typical antenna pattern for a 500 ft. antenna at 4 MHz, and Figure-3 shows a typical antenna pattern for a 500 ft. antenna at 1.9 MHz.

**Table-1 BevFlex-4X  
Performance Guidelines  
Above Ground Beverage**

## Antenna

Antenna Length	Overall Performance Vs. Band						Relative Directivity					
	160m	80m	40m	30m	20m	15m	160m	80m	40m	30m	20m	15m
100 ft.	P	F	G	G	E	E	Nil	P	G	E	E	E
150 ft.	F	F	G	E	E	E	Nil	F	G	E	E	G
250 ft.	G	G	E	E	E	E	F	G	E	E	E	G
350 ft.	E	E	E	E	G	G	G	E	E	E	G	F
450 ft.	E	E	E	E	F	F	G	E	E	E	F	P
550 ft.	E	E	E	E	P	P	E	E	E	E	P	P
750 ft.	E	E	E	G	P	P	E	E	G	G	P	P
950 ft.	E	E	G	G	P	P	E	G	G	P	P	P

E=Excellent, G=Good, F=Fair, P=Poor,  
NIL=Insignificant

**Figure-2 Typical Antenna Pattern for a 500 ft. BevFlex-4X Antenna @ 8 ft. above ground (4 MHz)**

3 dB Beam-width: 59.6°  
Front to Back Ratio: 20.6 dB  
Elevation Angle 29.0 deg.  
Outer Ring -4.4 dB ref.  
NEC-4 EZNEC Pro/4

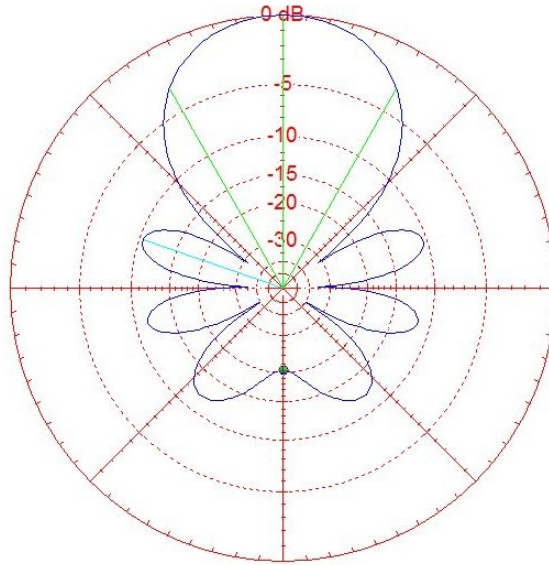

**Figure-3 Typical Antenna Pattern for a 500 ft. BevFlex-4X Antenna @ 8 ft. above ground (1.9 MHz)**

3 dB Beam-width: 86.2°  
Front to Back Ratio: 15.0 dB  
Elevation Angle 30.0 deg.  
Outer Ring -11.3 dB ref.  
NEC-4 EZNEC Pro/4

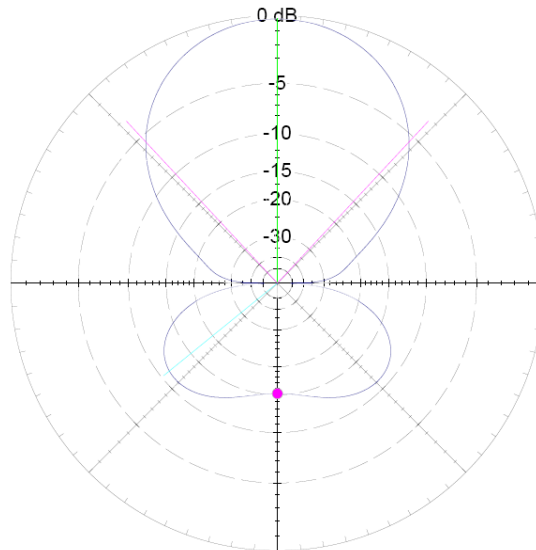

The Unified Microsystems BevFlex-4X Beverage antenna kit will enable you to construct a Beverage receiving antenna that has a uni-directional receiving pattern that can be reversed. In either of its two directional patterns, it is capable of providing

outstanding results for the reception of weak signals that are otherwise unreadable using your normal transmit antenna. The key receiving benefit of the BevFlex-4X is not to increase the received signal level, but to improve the received signal to noise ratio in the favored direction, especially on signals arriving from distant stations at a low elevation angle. All received signal levels will be lower on the BevFlex-4X than receiving on your transmit antenna, but you will now be able to hear signals that were buried in the noise on your transmit antenna. "If you can't hear them, you can't work them," even if they can hear you!

As a reminder, this is a **RECEIVE ONLY ANTENNA AND MUST NEVER BE CONNECTED DIRECTLY TO THE OUTPUT OF A TRANSCEIVER**. The application of more than a few milliwatts of power into the system will result in damage, and such damage is **NOT** covered by the warranty.

Figure-4 Above Ground Beverage Antenna

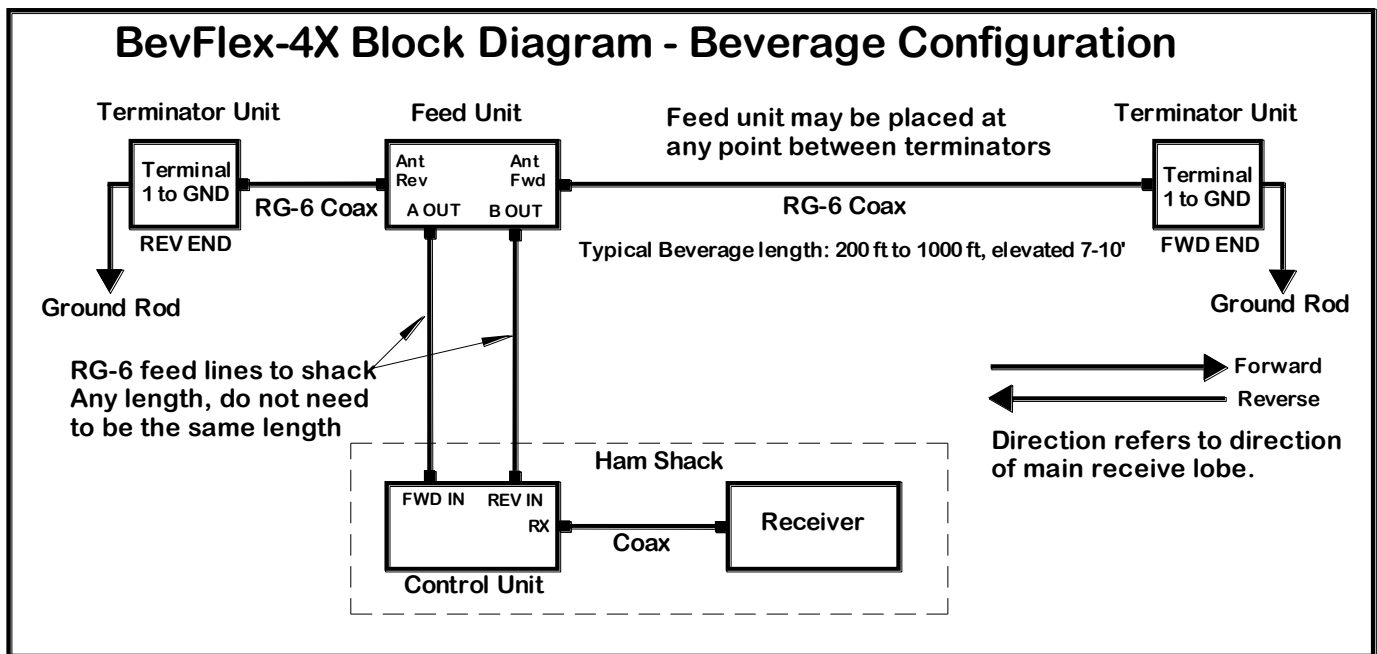

Figure-4 shows the wiring diagram for the entire Beverage antenna system.

Prior to installation, determine the directions you want the antenna to cover. For example, in the Northeast USA, pointing the antenna element axis at 45 degrees in the forward direction and 225 degrees in the reverse direction, allows optimum reception from Europe or the South Pacific areas. The uni-directional receiving pattern of the antenna will typically be about 60 degrees wide at the -3dB response points. Antenna directivity patterns will typically allow reception well off the primary axis of the antenna, which, unlike a dipole antenna, is off either end of the BevFlex-4X antenna element.

## **GENERAL INSTALLATION INSTRUCTIONS**

In addition to the BevFlex-4X kit, you will need to have the following items as part of your Beverage antenna installation:

**RG-6, 75 Ohm, CATV, coaxial cable:** Sufficient RG-6 coaxial cable for use as the actual antenna element, plus (2) separate, feed lines from the feed point anywhere along the antenna element to your receiver location. Any good quality RG-6 coaxial cable with or without a messenger support wire can be used. (1000 ft. spools of RG-6 cable can be obtained at local builder's supply stores or over the Internet.)

Use of 50 ohm coax is not recommended for either the Beverage antenna element or the feed lines back to the shack. The BevFlex-4x is designed for 75 ohm coax. Using coax with a different impedance will negatively affect the performance.

**Ground rods:** You will need one 4 ft. copper clad, steel, ground rod (1/2" or 3/4" copper water pipe can be used in soft ground), a wire clamp, and a short piece of #12 or #14 hook up wire for each end of the BevFlex-4X.

**Cable supports:** You will need insulated support devices to hang the RG-6 coaxial cable from trees or other supports. Simple plastic cable ties or electric fence wire insulators work well for this application.

**Weather proof Coaxial Connectors:** You will need at least (8) outdoor type "F" connectors and the proper tools to attach them to the coaxial cable. Weatherproof, compression type, "F" connectors with "O-ring" seals are recommended.

The application of a small amount of silicon grease to the threads on each of the "F" connectors during assembly is also recommended to keep the connections weatherproof and free of corrosion. Wrapping the connections with silicone rubber type fusion tape is recommended for a good weather tight seal that is easily removable for future repairs.

**Figure-5 "F" Connector Installation**

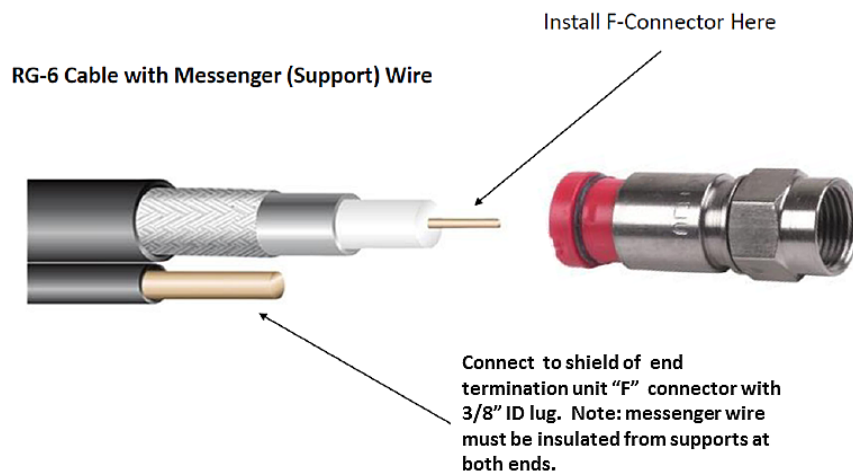

## **BEVERAGE ANTENNA INSTALLATION:**

1. Determine the location for your BevFlex-4X antenna and install a 4 ft. ground rod at one end. (Scrap copper water pipe can also be used in soft ground). Try to locate the BevFlex-4X antenna element as far as possible from your transmitting antenna and its counterpoise radials. Undesirable coupling between the BevFlex-4X and other antennas can degrade the directivity and noise performance of the BevFlex-4X. Close coupling of the BevFlex-4X to a transmitting antenna can also result in damage to the BevFlex-4X components and the receiver. It is recommended that the BevFlex-4X be spaced a minimum of 50 ft. from a transmitting antenna operating at power levels up to 1500 Watts. There is one exception to the spacing rule. Two BevFlex-4X antennas can be placed perpendicular to each other to provide reception in four different directions. In this case, the two perpendicular antennas can cross over each other as long as at least 12" of spacing between the two coaxial antenna elements is maintained. Multiple BevFlex-4X's can be used as a phased array, but this application is beyond the scope of these instructions. Using the measurement tool within Google Earth to place the antenna location and directional heading on your property can be a very helpful planning step.
2. The factory default settings for the internal jumpers in the termination units are for the Beverage/BOG configuration. See Table-3, Figure-19, and Figure-20 for more information.
3. Connect one end of the RG-6 coax cable used as the antenna to one of the Termination Units in the kit.
4. Connect a short piece of hook up wire (non-critical, #12 or #14 recommended) between the ground rod clamp and terminal stud # 1 of the end box for the above ground Beverage configuration or to stud #2 for the Beverage On Ground (BOG) configuration (using the default internal jumper settings). It is recommended that the Termination Unit be located near ground level and close to the ground rod with the F connector toward the ground.
5. Run the RG-6 coaxial cable between the two end points maintaining relatively constant height above ground and keeping track of your direction of travel. The RG-6 coaxial cable should be insulated from the supporting trees or other supporting structures. Several different types of electric fence insulators are readily available for this purpose. A height of 7 to 10 feet above ground is ideal and keeps the wire high enough to allow mowing under the antenna and to reduce the possibility of damage from passing people or animals. (antenna heights as low as 18 inches above ground level can be used, but make the antenna more vulnerable to damage) Variations in the height above ground due to uneven terrain or uneven support heights will have little effect on the antenna performance.

The RG-6 coaxial cable can follow the general contour of the land if you are going up and down hills and can be supported by tree limbs with cable ties or tree trunks with "nail on" electric fence insulators. Whichever type of supports you use, allow the coaxial cable antenna element to slide freely though the supports to allow for expansion and contraction as well as movement of the supporting trees, etc. The RG-6 coaxial cable comprising the antenna element does not have to go in an exact straight line on the desired heading. It is OK for the antenna to zig-zag a few feet in either direction as long as the average heading of the antenna element is maintained. A moderate amount of symmetrical zig-zag of the antenna element coaxial cable actually introduces some "electrical loading" and reduces the velocity factor of the antenna, making it perform as if it were physically longer than it actually is. **BE SURE TO ALLOW A FEW EXTRA FEET OF RG-6 COAXIAL CABLE AT THE POINT WHERE YOU INTEND TO FEED THE SIGNALS BACK TO YOUR SHACK.** It is necessary to provide stress reduction loops where the Feed Unit will be connected.

Using RG-6 cable with a messenger wire is suggested for elevated Beverage antennas with widely spaced supports. The messenger wire provides support for the coaxial cable. Follow these guidelines when using this type of coax.

- The ends must be insulated from ground and metal objects at the ends.
- Connect the ends to the F connector on the Terminator Units. Use a 3/8" ring lug and a 3/8" hex nut over the threaded portion of the Terminator F connector. Leave enough length to provide a drip loop to prevent water from entering the Terminator unit. You might want to splice stranded wire to the messenger wire and use that to the ring lug for flexibility.
- Maintain continuity of the messenger wire at the Feed Unit. If necessary, splice the messenger wires from the two coaxial antenna sections.
- Waterproof messenger wire connections as you would any other antenna conductor



6. At the far end of the antenna, install the other **Termination Unit** from the kit the same way as in instructions #2 and #3 above.
7. The feed point for the BevFlex-4X can be located at any point along the entire length of the coaxial cable antenna element. If you are feeding it from either end, simply connect the feed box from the kit directly to the end box with a short RG-6 coaxial jumper or an “F” male to male barrel adapter. Locate the feed point at the position most convenient to your receiver location. The entire length of the coax run is always used as the antenna regardless of where the Feed Unit is placed.
8. Install two RG-6 coaxial cables from the Feed Unit supplied with the kit to your receiver location. You can use two independent runs of RG-6 coaxial cable or the “Siamese twin” type dual RG-6 coaxial cable. The length and matching of the length on these feedlines are not critical. The Feed Unit provides both common mode RF and DC / Ohmic isolation of the feedlines from the antenna. It is recommended that the shields of the two feedlines be connected to the station ground at the entrance to the ham shack to provide static discharge and lightning protection. This can be easily accomplished using a standard CATV, dual, grounding block like the one shown in Figure-6. Winding each coax through separate ferrite toroids will help reduce any common mode noise picked up by the feed lines.

**Figure-6 F Connector Grounding Block**



**9. NOW IS A GOOD TIME TO INSPECT AND WEATHERPROOF ALL OUTDOOR CONNECTIONS!** Silicon rubber type fusion tape is recommended for a good weather tight seal that is easily removable for future repairs. The application of silicon grease to the threads on the “F” connectors also helps to keep the connections weatherproof and free of corrosion.

All connections to the outdoor BevFlex-4X Terminator and Feed Units must have drip loops installed, or the wire or RG-6 coax must orient towards the ground. This prevents water from accumulating at the connection point and possibly entering the enclosures. Figure-7 shows proper wire and coax routing.

**Figure-7 Proper Wire and Cable Routing.** Note picture also this shows the wire attachment for loop configurations. Beverage and BOG configurations would only have the coax and wire to the ground rod on one of the screw terminals.



10. Connect the two RG-6 coaxial cables to the feed point box, making note of which cables connect to the “A” and “B” labels on the box. Mark the cable ends on both cables and connect them to the corresponding “Forward” and “Reverse” labels on the indoor Switch Unit. (Note: these connections are reversed in the EWE and FLAG configurations)

11. Connect a user provided, 50 Ohm coaxial cable (impedance not critical) from the “RX” terminal on the Switch Unit to the RECEIVE input on your radio. (User provided RCA phono or BNC adapters may be required to mate with the control unit and the appropriate input on your transceiver)

**DO NOT CONNECT THE BevFlex-4X TO ANY TERMINAL CAPABLE OF TRANSMITTING, AS YOU MAY DAMAGE THE BevFlex-4X ANTENNA COMPONENTS!** If your receiver or transceiver does not have a separate “receiver antenna” input terminal, you will need to provide an external transmit/receive relay that is controlled by the PTT function on your transceiver such as:

DX Engineering RTR-2 Receive Antenna Interface

MFJ-1707 AUTOMATIC RF SENSE ANTENNA SWITCH

### **Notes of caution:**

***As stated at the beginning of this document, the BevFlex-4X is a RECEIVE ONLY antenna system and must be protected from accidental application of RF power to the Rx output “F” connector or any of the other system RF connectors. The BevFlex-4X antenna should be located as far as possible from transmitting antennas ( 50 ft minimum separation from a 1500W transmitting antenna) to provide best receive performance and to protect the receiver from damage. The BevFlex-4X antenna switching and termination unit has RF limiting diodes to protect the receiver from nearby transmitted signals up to a fairly high level of 100 mW (0.1 Watt) or +20dBm, but the***

*system can still be damaged from close coupling to a transmitting antenna. The limiting diodes begin to operate at 1.1Volts RMS or +12dBm and reach a fully limited output of 3.0Volts peak to peak at +20dBm. If you are close to a broadcast transmitter that drives the protection diodes into conduction, you may experience intermodulation distortion to the desired signals you are trying to receive. Try re-orienting the BevFlex-4X to reduce the nearby, strong, interfering signal, or contact Unified Microsystems Antennas for other suggestions.*

*The antenna switching and termination unit is also protected against accidental application of RF power from the transmitter by a small fuse, which can be seen if you open the unit (See Figure-10). Should you accidentally blow this fuse, the unit will be non-operational. If this occurs, you can replace this fuse with an identical 50 ma fuse available from Unified Microsystems (Bell P/N MRF 50, available from DigiKey and Mouser ) or insert a small jumper wire or 10 ohm resistor across the pads G2. If you bridge the blown fuse with a resistor or jumper, the future protection of the BevFlex-4X system will be compromised.*

*The inputs from the antenna feed lines have Ohmic isolation from the feedline to the receiver input. If you have a reason to provide a DC connection between the feedline shields and the shield of the coaxial cable to the receiver input, you can make the connection with a jumper wire in the G1 pads inside the Switch Unit. It is recommended that you leave this jumper out (factory default) because it provides better isolation to your receiver and also reduces common mode noise that might be picked up on the feed lines from the Feed Unit.*

**Figure-8 Indoor Antenna Direction Switch Unit Front Panel**



Figure-9 Indoor Antenna Direction Switch Unit Rear Panel



Figure-10 Indoor Antenna Direction Switch Unit Fuse Location

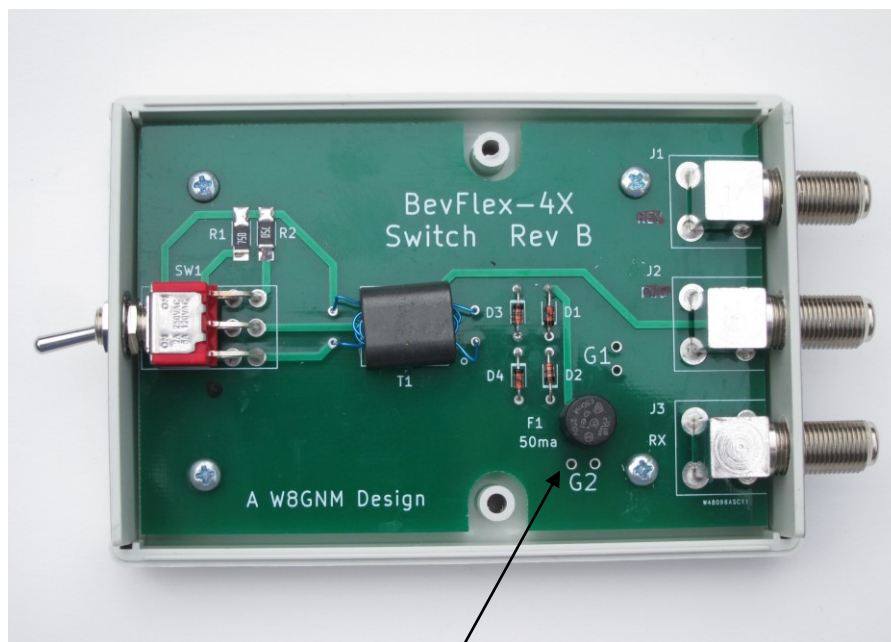

50 ma. Fuse

***If your transceiver does not have a separate receive antenna connector, be very careful about using an external switching arrangement to create a receive antenna function external to the transceiver. Many of these external T/R relays do not have enough isolation and fast enough switching time to protect the BevFlex-4X. If your transceiver has an adjustment to delay RF output for a time interval after the PTT keying is activated, this delay should be set to at least 25 milliseconds to avoid hot RF switching, and possible damage to receiver or the BevFlex-4X receive***

**antenna system. It is known that the SPE Expert linear amplifier internal antenna switch will not adequately protect the BevFlex-4X.**

## **TESTING AND OPERATION**

An antenna analyzer can be useful to determine that the antenna is correctly installed and functional. By connecting the analyzer to the “RX” port on the **Switch Unit** and sweeping the frequency from 1.8 to 10 MHz, you should see a relatively flat and non-fluctuating (but not necessarily extremely low) VSWR that is less than approximately 2:1 (referenced to 50 Ohms). Listening to various signals, you should observe lower atmospheric and man-made noise levels than on your transmit antenna as well as a significant (sometimes more than 20 dB) front to back ratio when switching directions.

Spend time listening to signals from several directions on different frequency bands and compare the signal to noise ratio to your other antennas. There are several HF broadcast signals that can be helpful in determining the performance of your BevFlex-4X receiving antenna system.

For example, in the eastern USA:

- Gander and New York aviation weather broadcasts on 3,485kHz and 10,051kHz (USB mode)
- CHU Canada time and frequency references on 3,330 kHz and 7,850 kHz

WWV time and frequency reference on 2,500, 5,000, and 10,000kHz These are all reliable and predictable HF sources that can aid in understanding the performance of your antenna.

Also, try listening to AM broadcast stations in known directions relative to your BevFlex-4X’s favored directions. Listen to both daytime ground wave and night time skywave. Note that F/B measurements should be made during daylight hours. At night, stations off the back end will pop in and out quickly, making accurate F/B measurements difficult.

You will notice that all received signal levels will generally be more than 10dB lower than on your transmit antenna, but the signal to noise ratio on the BevFlex-4X will typically be much better than on your transmit antenna for signals coming from the favored direction of the BevFlex-4X antenna. The lower overall received signal strength is not usually a problem since the sensitivity and excellent noise figure of modern receivers/transceivers are good enough to make up for this difference in strength. The signal and noise levels on the lower HF bands below 10 MHz are far above the receiver signal to noise thresholds even when using the BevFlex-4X antenna system.

We hope you will find the BevFlex-4X receiving antenna system a highly useful and satisfying tool for digging signals out of the noise to hear what you could not hear on your other antennas.

### 3. Beverage-On-Ground (“BOG”) or Beverage-In-Sod (“BIS”)

The BOG antenna that is sometimes referred to as a “snake” antenna is nothing more than a BevFlex-4X installed on, just under, or a few inches just above the ground surface. While it might seem counterintuitive to have your receive antenna at or slightly (less than 1 inch) below ground level, it does work and has some interesting feature differences when compared to an above ground Beverage installation. The BevFlex-4X installed as a BOG retains the same advantages with respect to the use of RG-6 coax for the antenna element and feed lines as well as the ability to feed it from any point along its length. In addition, since the velocity factor of the antenna wire at ground level is much lower than a wire above ground, the overall electrical length of the antenna is nearly twice as long as the physical length of the antenna. This extended electrical length characteristic, along with the ability to hide the antenna in sod, can put the advantages of this low noise receiving antenna within reach of those with limited space or HOA restrictions on antennas.

The BOG installation performance will be close to that shown in Table-2 and Figure-11. One major difference, however, will be that the overall signal level will be lower than a traditional above ground Beverage antenna. The signal levels can be improved by mounting the BOG an inch or two above ground level when it can be protected from being a tripping hazard. BOG lengths between 100 feet and 240 feet generally work well with 225 feet being the optimum length for 160m operation over normal soil. While signal levels from a BOG will normally be sufficient for lower frequencies below 7 MHz, the use of the BevFlex-4X in a BOG configuration above 7 MHz may require the use of a low noise preamplifier at the output of the switch box.

**Table-2**  
**BevFlex-4X Performance Guidelines for**  
**Beverage Antenna On Ground (BOG)**

Antenna Length	Overall Performance Vs. Band			Relative Directivity		
	160m	80m	40m	160m	80m	40m
100 ft.	F	G	G	F	G	G
150 ft.	F	G	G	G	E	G
200 ft.	G	E	G	G	G	G
225 ft.	E	E	G	E	G	G
300 ft.	G	G	G	G	G	G

E=Excellent,      Operation at 40m and above  
G=Good,            may require a pre-amplifier  
F=Fair, P=Poor,  
NIL=Insignificant

**Figure-11 Typical Antenna Pattern for a 175 ft. BevFlex-4X Beverage on Ground Antenna (BOG @ 1.9 MHz)**

3 dB Beam-width: 98.6°  
 Front to Back Ratio: 15.1 dB  
 Elevation Angle 35.0 deg.  
 Outer Ring -21.6 dB ref.  
 NEC-4 EZNEC Pro/4

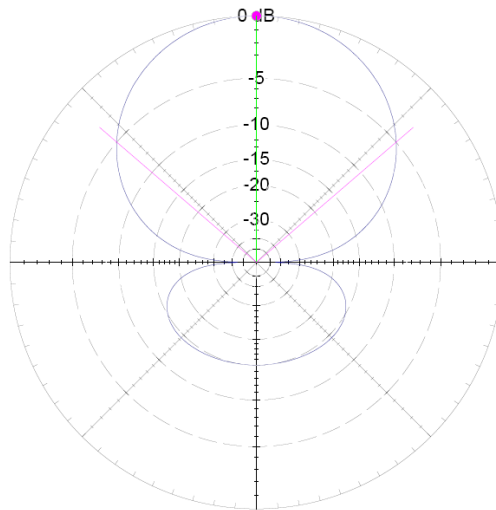

**Figure-12 Beverage-On-Ground Antenna Block Diagram**

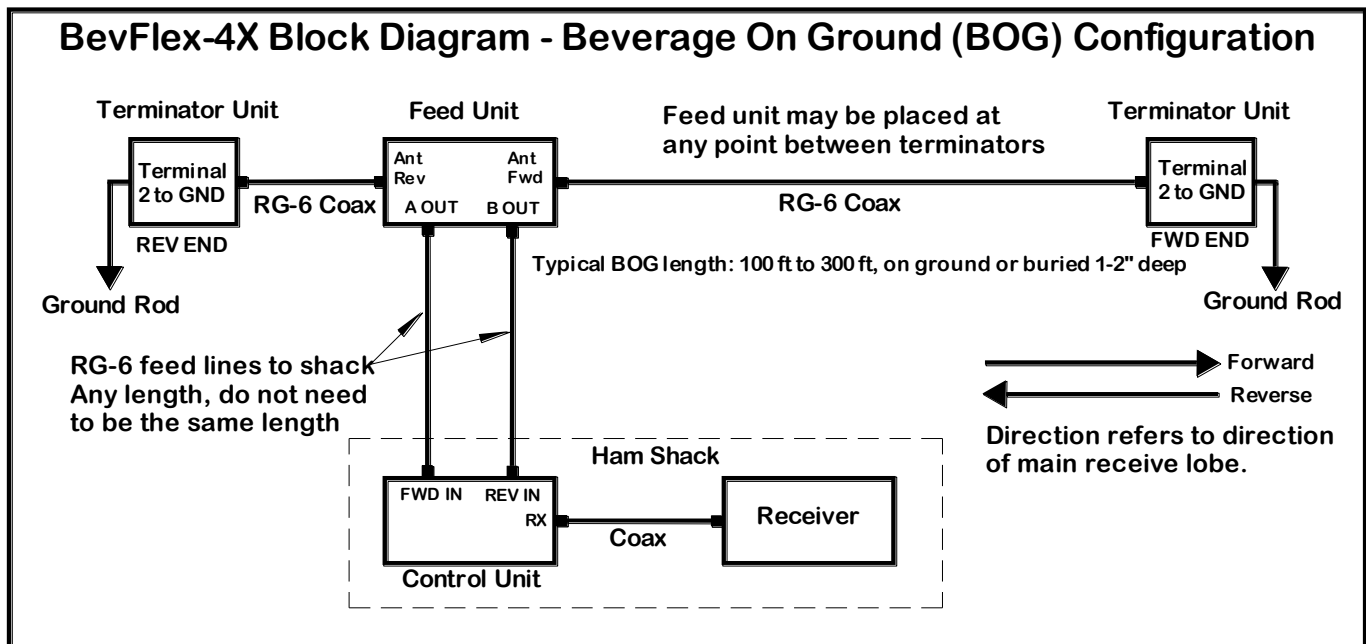

Installation of this antenna configuration is similar to the classic, above ground Beverage described above except different studs on the termination units are used to connect to the ground rods. See Figure-12 above for details.

The Terminal Units come factory configured for Beverages and Beverage on Ground. See Table-3, and Figure-19 and Figure-20 for more information on setting the internal jumpers.

#### 4. EWE Antenna

The inverted EWE antenna was first described by Floyd Koontz, WA2WVL, and documented in the February 1995 edition of QST. It is, by far, the smallest of the four receiving antenna variations possible with the BevFlex-4X system. The EWE consists of a single wire element in an upside down "U" configuration, as shown below. The EWE is not a traveling wave antenna like the Beverage and BOG, but is really a phased array of two, short, vertical, antennas that are top coupled by the horizontal wire. The EWE antenna is a good performing, low frequency, receiving, reversible, antenna you can deploy in a very small space. Each end of the EWE is fed back to the operating position with RG-6 coax. Like the Beverage and the BOG, a four ft. ground rod must be installed at each end of the EWE.

The Terminator Unit internal jumpers must be configured for EWE use. The factory setting is for Beverage type antennas. See Table-3 and Figure-19 and Figure 20 for more information on configuring the jumpers in the Termination Units

If the ground conductivity is poor, an additional wire connected between the ground rods and buried just beneath the ground may help the performance of the EWE antenna. The box normally used as a "feed point unit" for Beverage and BOG installations is now used as an isolation transformer to maintain balance and eliminate ground loops. Note that the coaxial feed-line connections to the switching control unit are reversed from the Beverage connections when the BevFlex-4X is configured as a EWE or FLAG antenna system.

**Figure-13 Typical Antenna Pattern for a 40 ft. x 10 ft. EWE (1.9 MHz)**

3 dB Beam-width: 149.2°  
Front to Back Ratio: 23.9 dB  
Elevation Angle 32.0 deg.  
Outer Ring -24.3 dB ref.  
NEC-4 EZNEC Pro/4

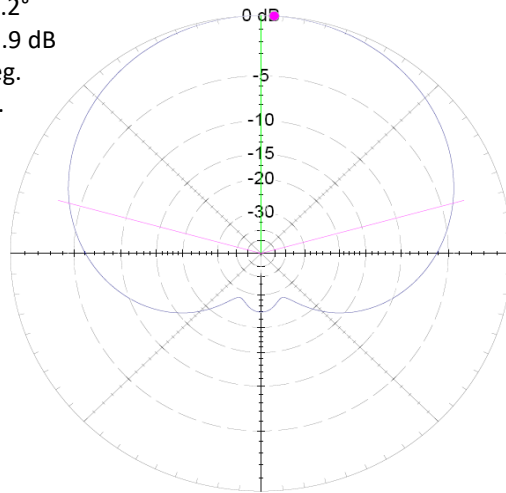
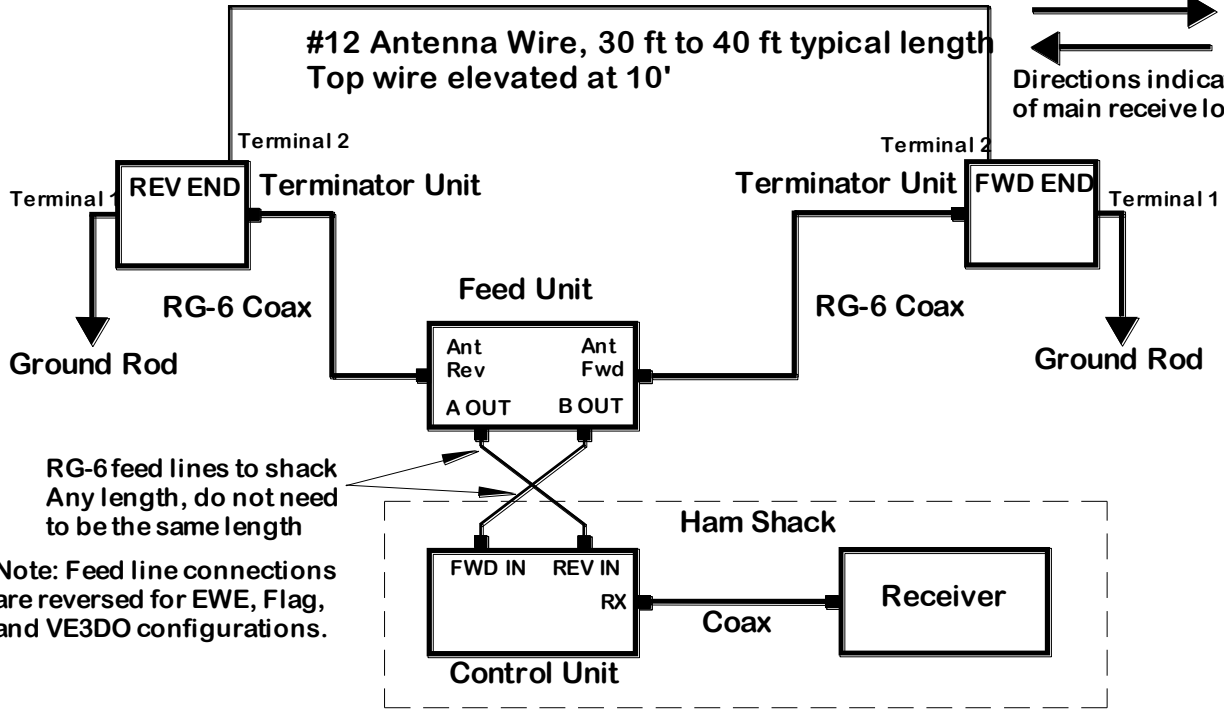

**Figure-14 EWE Antenna Block Diagram**



# BevFlex-4X Block Diagram - EWE Configuration

Directions  
 → Forward  
 ← Reverse  
 Directions indicate direction of main receive lobe.



## 5. Flag Antenna

The Flag antenna is a rectangular, single wire element with dimensions of approximately 34 ft. wide x 16 ft. high and is typically installed 10 to 25 ft. above ground. The Flag, like the EWE, is not a traveling wave antenna like the Beverage and BOG, but is really a phased array of two, short, vertical, antennas that are top coupled by the horizontal wires. It may also be thought of as a pair of back-to-back EWE antennas mounted above ground. Details of Flag operation theory and performance are widely available on-line.

**Figure-15 Typical Antenna Pattern for a 34 ft. x 16 ft. Flag @ 10 ft. (1.9 MHz)**

3 dB Beam-width: 150.8°  
Front to Back Ratio: 33.2 dB  
Elevation Angle 31.0 deg.  
Outer Ring -29.7 dB ref.  
NEC-4 EZNEC Pro/4

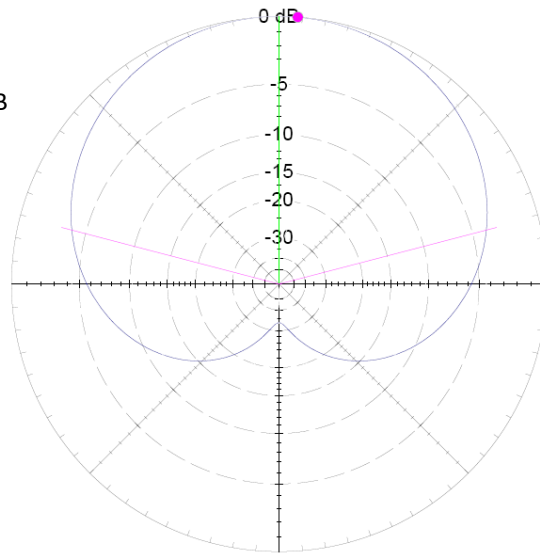
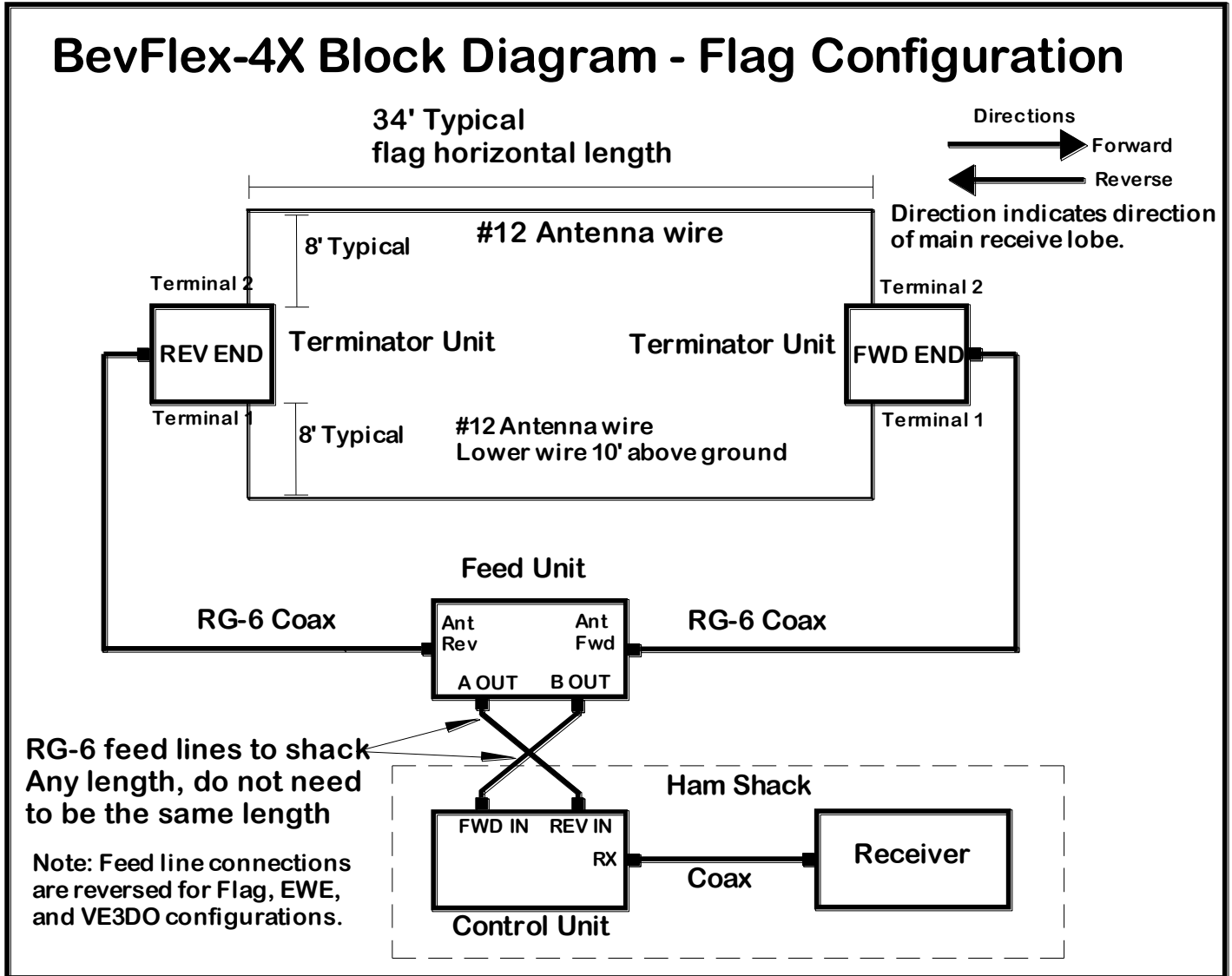

Figure-16 below shows a typical Flag antenna installation.

Figure-16 Flag Antenna Block Diagram



Like the EWE, the Flag has a feed point on one vertical element (forward direction) and a termination point on the other vertical element (reverse direction). By selecting the appropriate taps on the BevFlex-4X universal termination units, the Flag now is reversible with individual RG-6 coax feed lines connected via the termination unit to each of the two vertical elements, as shown. The box normally used as a “feed point unit” in Beverage and BOG installations is now used as an isolation transformer to maintain balance and eliminate ground loops in the system. Note that the coaxial feed-line connections to the switching control unit are reversed from the Beverage connections when the BevFlex-4X is configured as a Flag or EWE antenna system. The major advantage of the Flag antenna is retention of reasonable low frequency, low noise performance with a much smaller real estate requirement than either the Beverage or BOG. Figure-15 shows a typical Flag antenna pattern.

The Terminal Unit internal jumpers must be reconfigured for Flag antenna use. The factory setting is for Beverage type antennas. See Table-3 and Figure-19 and Figure-20 for more information on configuring the jumpers in the Termination Units.

## 6. VE3DO Antenna

The VE3DO antenna is similar in configuration to the EWE antenna except for the vertical ends of the antenna wire, which are folded back parallel to the ground to the center of the horizontal part of the antenna where the two end Terminator Units share a single ground rod. The horizontal bottom wires are suspended about 18" above ground level. More information about the VE3DO antenna is available at the following link:

<http://audiosystemsgroup.com/VE3DO.pdf>

The Terminal Unit internal jumpers must be configured for VE3DO use. The factory setting is for Beverage and BOG type antennas. See Table-3, and Figure-19 and Figure-20 for more information about configuring the Termination Units for the VE3DO antenna.

**Figure-17 Typical Antenna Pattern for a VE3DO (1.825 MHz)**

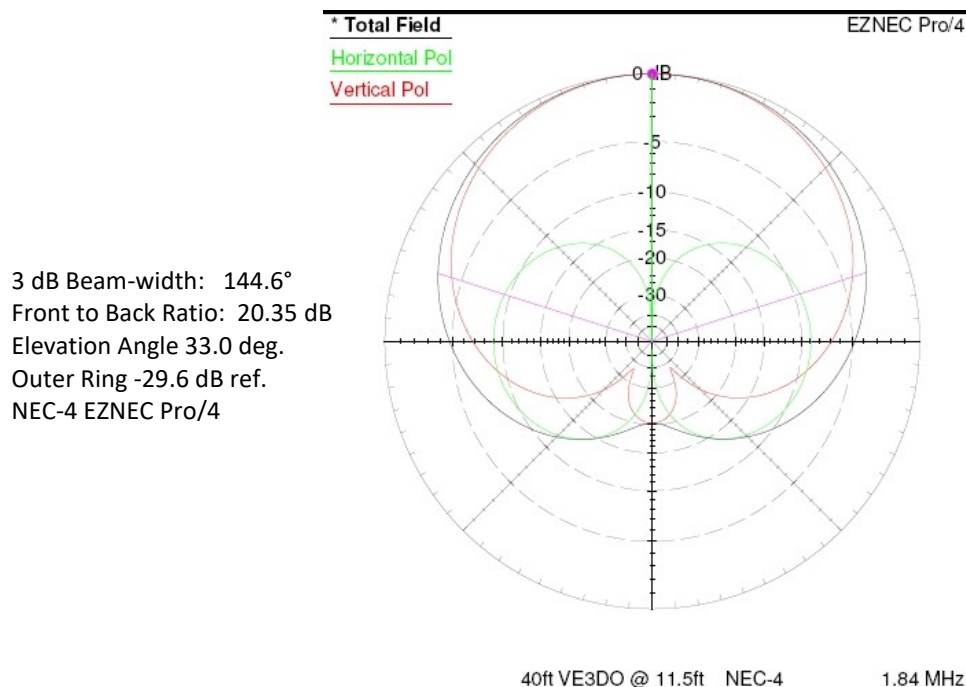
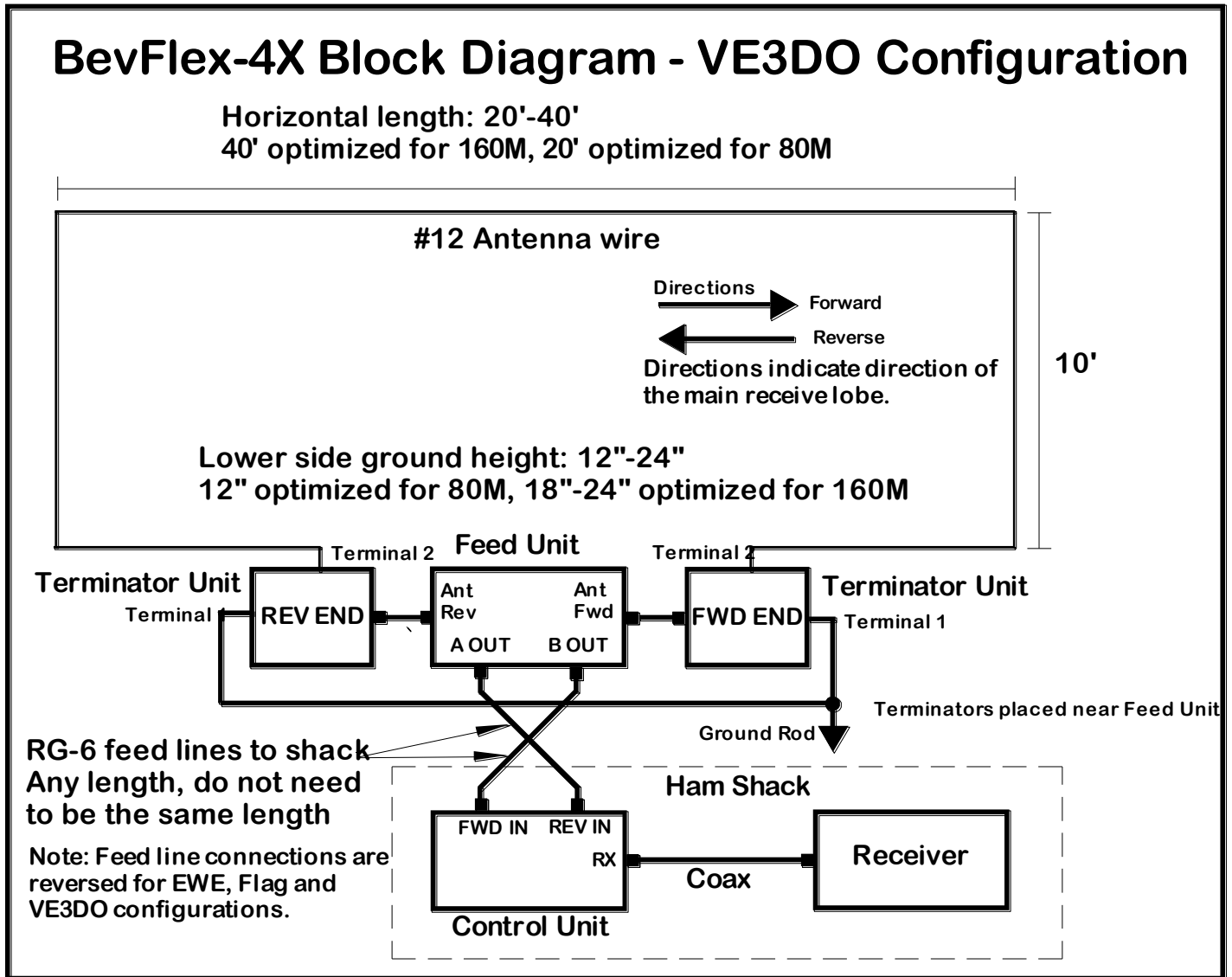

Figure-18 VE3DO Antenna Block Diagram



### 7. Terminator Unit Connections and Configuration

The different antennas supported have different impedances. The Terminator Units have different taps and terminals to account for the different impedances. Table-3 summarizes the connections and internal jumpers for the antenna types supported.

**Table-3 End Terminator Stud & Internal Jumper Connections For Each Antenna Type**

<b>Antenna Type</b>	<b>Terminator Unit Stud #1</b>	<b>Terminator Unit Stud #2</b>	<b>Terminator Unit Internal Jumper G1</b>	<b>Terminator Unit Internal Jumper G2</b>	<b>Notes</b>
Classic Beverage Above Ground	Connect to Ground Rod	Not Connected	2-3	1-2	<i>Factory Configuration</i>
Beverage on Ground (BOG)	Not Connected	Connect to Ground Rod	2-3	1-2	<i>Factory Configuration</i>
EWE	Connect to Ground Rod	Antenna Wire connection to Other Terminator	1-2	2-3	
Flag	Lower Wire Connection to Other Terminator Stud #1	Upper Wire connection to Other Terminator Stud #2	1-2	2-3	
VE3DO	Connect to other Terminator Stud #1 and to a single ground rod	Antenna Wire connection to Other Terminator Stud #2	1-2	2-3	

### **Terminator Internal Jumper Settings**

The five antenna types supported with the BevFlex-4X have different impedances that must be matched to 75Ω RG-6 coax. That is the job of the terminator units. Jumpers inside the terminator units select the proper taps on the impedance matching transformer. Jumpers G1 and G2 must be set for the antenna system type you are building.

The factory default is for Beverage/BOG configurations. You will need to change the jumpers if you are building a Flag, EWE, or VE3DO antenna. If you are unsure of how the jumpers are set, measure the resistance between one of the terminator stubs and the outer shell (shield connection) of the F connector with an Ohm meter. A low resistance indicates it is set for the Beverage/BOG configurations, where the coaxial cable is used as the antenna.

Figure-19 Jumper settings for Beverage/BOG

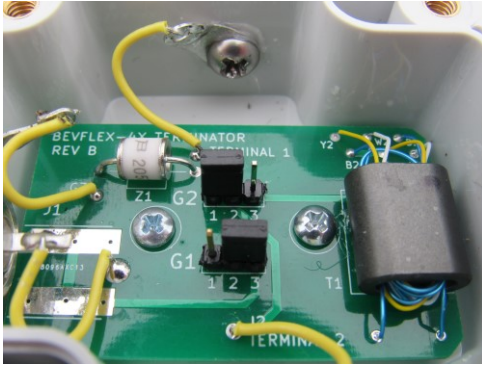
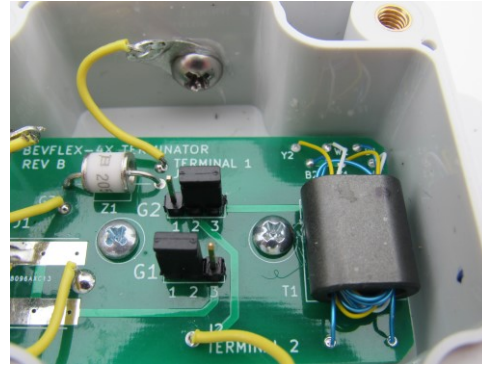

Figure-20 Jumper settings for EWE/FLAG/VE3DO



Use care when reinstalling the cover. Partially install all four screws before tightening them down to prevent stripping the case brass inserts. The cover must be installed with the Unified Microsystems URL towards the F connector.

## 8. Using Other Coax Switches

The BevFlex-4X Switch Unit provides two purposes. One is that it selects the coax for the desired listening direction. The other function is to terminate the unused coax in 75 ohms. This is required for proper operation of the antenna. Running multiple coax runs to the shack may be undesirable, especially if you have multiple BevFlex-4X systems to cover all directions.

You can use a remote switch to bring a single line back to the shack. It is important to ensure that unused coax lines from the switch to the Feed Units are terminated with a 75 non-inductive resistor. Commercial coax switches for transmitting use normally leave unselected ports open or shorted to ground. Some remote switches designed for receive antennas terminate unused ports, but they might be 50 or 75 ohms. You will need to verify that the switch you use provides the proper 75 Ohm termination, and if necessary, make modifications.

## 9. Troubleshooting the BevFlex-4X System

To fully test all the components of the BevFlex-4X system, you will need an RF antenna analyzer in addition to an Ohmmeter. The RF analyzer is required because most of the connectors on the BevFlex-4X system components are terminated in transformers, which will measure as very low resistance readings on an Ohmmeter. There are a few simple DC measurements that can be made using an Ohmmeter with the ability to measure low values of resistance to verify that the transformer windings are intact and the coaxial cables are correctly connected.

Before measuring the DC resistance on the BevFlex-4X components, verify your Ohmmeter is calibrated to read zero ohms when the test leads are shorted together.

### Terminator Unit DC resistance measurements:

- The resistance measured with an Ohmmeter from the center pin of the “F” connector to the outer shield on the end termination unit should measure less than 1 Ohm showing that the transformer winding is intact.
- The resistance measured with an Ohmmeter from terminal #1 to terminal #2 on the end termination unit should be less than 1 Ohm showing that the other transformer winding is intact.

### Feed Unit DC resistance measurements:

- The resistance measured with an Ohmmeter from the center pins of all four of the “F” connectors to their respective outer shields should measure less than 1 Ohm showing that all the transformer windings are intact.
- The resistance measured with an Ohmmeter from the antenna forward “F” connector threads to the antenna reverse “F” connector threads should measure less than 1 Ohm.
- The resistance measured with an Ohmmeter from either the antenna forward “F” connector or the antenna reverse “F” connector should measure as an open circuit to shield of either the A or B feedline “F” connectors.

### Switch Unit DC resistance measurements:

Here are some simple tests with an Ohmmeter to check the functionality of the Switch Unit.

- If a transmitter or transceiver accidentally feeds RF power into the Rx port of the control box, a micro-fuse will open to protect the BevFlex-4X receiving antenna components. You can easily check the condition of this fuse by measuring the resistance from the center pin of the Rx connector to shield ground. The resistance should measure approximately 8 Ohms. If this port measures open, the fuse has blown. With the direction switch in the “Forward” position, the resistance reading from the center pin of the A port to shield should be approximately 75 Ohms. With the direction switch in the “Reverse” position, the resistance reading from the center pin of the B port to shield should be approximately 1 Ohm. This is the resistance of the transformer winding.
- With the direction switch in the “Reverse” position, the resistance reading from the center pin of the B port to shield should be approximately 75 Ohms. With the direction switch in the “Forward” position, the resistance reading from the center pin of the A port to shield should be approximately 1 Ohm. This is the resistance of the transformer winding.

## 10. Warranty and Support Information

The BevFlex-4X is warranted for parts and workmanship for a period of one year from the time of purchase. Unified Microsystems will repair or replace failed units at its discretion. Physical or lightning damage is not covered under warranty.

Unified Microsystems may make changes to the design or specifications without notice.

### Support

Support for Unified Microsystems products is available by email. [w9xt@unifiedmicro.com](mailto:w9xt@unifiedmicro.com) Include the product name (BevFlex-4X) in the subject line for the fastest response.

### Disclaimer

Installing antennas can be dangerous. Use caution when installing your BevFlex-4X antenna system. Stay away from power lines. Unified Microsystems is not responsible for injuries sustained while installing its products.

Always disconnect your BevFlex-4X antenna and all other antennas when not operating to prevent lightning damage. Unified Microsystems is not responsible for injuries or equipment damage due to improper installation, lightning, or similar events.

Unified Microsystems  
PO Box 133  
Slinger, WI 53086  
[www.unifiedmicro.com](http://www.unifiedmicro.com)





## **11. Frequently Asked Questions about the BevFlex-4X**

### **1. What is unique about the BevFlex-4X product?**

The Unified Microsystems BevFlex-4X is a kit that allows you to construct the best possible, reversible direction, low frequency, receiving antenna system for your particular situation. By simply changing jumpers on the termination boxes, you can create a classic, above ground Beverage, Beverage on ground (BOG), Flag, inverted EWE antenna, or VE3DO antenna. No other product on the market offers the ability to create all five configurations and CHANGE them if and when your installation situation changes. Although the classic Beverage antenna configuration should yield the best results, the BevFlex-4X kit allows you to experiment and find what works best for you within the limitations of your location.

### **2. With five possible configurations, which one is the best?**

That all depends on the real estate you have available and which directions are most important to you for low noise, low frequency, receiving. All five configurations have been and still are successfully used by world class DX'ers. As a general rule, the performance rating order would be:

**Beverage** - The longer, the better (200 to 1000 ft.), Installed above ground

**BOG** - Same concept as Beverage, but placed on the ground or just above the ground - can be much shorter, but has reduced gain, particularly at higher frequencies.

**Flag** - A balanced antenna with two parallel above ground conductors. It requires considerable planning with regard to the supporting structure. The Flag produces higher signal levels than EWE or VE3DO antennas. Flag antennas can be constructed to be rotatable.

**Inverted EWE** – An unbalanced, short, above ground, antenna with simple support requirements.

**VE3DO** - A balanced antenna with two parallel above ground conductors. Similar performance to EWE, but has higher signal levels and only requires one ground rod.

(The FLAG, inverted EWE, and VE3DO require MUCH less physical space than either the Beverage or the BOG.)

### **3. What is the main difference between a Beverage and a BOG configuration?**

The Beverage antenna is installed ABOVE ground—typically 7-10 ft. above the surface, while the BOG is installed at or just below (less than 1”) the surface of the ground. It can be installed in sod, as a BIS (Beverage In Sod), or just above ground level, to improve its gain. A BOG can generally be made much shorter than the above ground, Beverage, due to its lower velocity of propagation factor. 240' is the optimal length for 160m operation over normal soil. The BOG can provide similar results to an above ground Beverage twice the physical length of the BOG, but with a reduction in overall gain.

### **4. What is the main difference between a FLAG and an inverted EWE antenna configuration?**

The FLAG antenna is a balanced antenna configuration, while the inverted EWE is unbalanced. In simple terms, the inverted EWE looks much like half of a FLAG antenna. The FLAG requires a slightly more complex installation due to having two parallel wire elements above ground, while the inverted EWE only requires one. Several users of the inverted EWE claim enhanced results in poor conductivity soil, by placing a small ground radial field at each end of the antenna or by connecting the two ground rods with a wire that is buried in the ground between them. This is not required for the FLAG configuration.

**5. What is special or new about this Beverage antenna kit vs. others that are available?**

The BevFlex-4X has the unique ability to be fed from any point along its entire length. Plus, it utilizes inexpensive RG-6 coax cable vs. more expensive ladder line that is required for other reversible direction systems.

**6. What bands does this antenna cover?**

The BevFlex-4X antenna is capable of receiving all HF bands, as well as the AM and LW broadcast bands. The most dramatic reception improvements are usually in the 1.8, 3.5, 7.0, and 10 MHz. amateur bands. It is still usable on 20m through 10m bands and down to 100 kHz.

**7. How does the overall system cost of this antenna compare with other Beverage antennas available?**

The overall cost of the BevFlex-4X system is lower than any other commercially available system on the market due to the use of low cost CATV type RG-6 coaxial cable for all portions of the antenna and feed system. The system is entirely passive, which reduces cost (no pre-amp, remote relays, or power injector required) and increases reliability.

**8. Which is better, a shielded loop, or a Beverage antenna? Both are advertised as low noise receiving antennas.**

Both antennas have advantages and disadvantages. Although there will be few cases where the loop may nearly equal the performance of the BevFlex-4X, the main advantage of the loop is that it requires no significant space. The loop can be rotated to null out specific, local, noise sources. If you are receiving signals from the directions favored by the Beverage polar pattern, the BevFlex-4X will always outperform the loop. A combination of the loop and the BevFlex-4X as a phased array using a two-input antenna noise cancelling device is a very powerful noise suppression tool.

**9. What is the optimum height above ground where I should position the Beverage antenna cable?**

7 to 10 feet above ground is ideal in that it maintains the correct impedance as well as allowing for mowing under the antenna and minimum interaction with wandering people and animals.

**10. Can I install the Beverage antenna on the slopes of hills on my property without the need for the terrain to be flat in elevation for the best results?**

Absolutely! Simply follow the contour of the land, whether it is flat or hilly. Crossing a creek or depression in the ground will have little impact on the antenna's performance. The ground under the BevFlex-4X does not need to be flat. You can even install it on a moderate hill side.

**11. How much can I deviate from a straight line in azimuth and still get good results as I layout the cable?**

Although the ideal situation is to have a long antenna run in a perfectly straight line, deviations of 20 to 30 degrees from the desired direction are acceptable. Try to keep the average direction correct as you install the antenna, but do not worry too much about necessary variations to accommodate your situation. Symmetrical, horizontal, zig-zags in the direction of the BevFlex-4X antenna wire where space is limited, can actually be helpful by providing some loading of the antenna which effectively increases the antenna's electrical length versus its physical length.

**12. Can I attach the RG-6 antenna cable to metal fence posts with wire ties, or do I need to use some type of insulator to standoff the cable from the metal post?**

Insulated supporting posts or trees have the least impact on BevFlex-4X performance. Metal posts can be used if the antenna element is supported with an insulator at least 18" above / away from the metal post. The antenna performance will be significantly degraded if there are any nearby wires running parallel to the antenna element.

**13. *What is the best kind of RG-6 cable to use? Quad-shield, standard single-shield RG-6 or 75 Ohm coax with a carrier support wire?***

Quad shield is ideal, but not necessary. The better the shielding, the less likely you will pick up unwanted interference. We recommend using a good quality cable with a UV resistant jacket and weatherproof connectors. Any good quality 75 Ohm characteristic impedance coaxial cable can be used, including coaxial cables that incorporate a supporting, steel messenger/carrier wire. RG-6 cable with a solid, copper, inner conductor are less susceptible to migration of the center conductor at sharp bends than cables that use a (CCS) copper clad steel inner conductor.

If long spans are required between supporting posts or trees, the use of coax with a supporting messenger/carrier wire is desirable. Much of the surplus coaxial cable from CATV companies has an integrated messenger wire and can often be obtained for free. If the cable has a supporting messenger wire, this wire needs to be insulated from the end supports and all intermediate supporting structures. Normally the messenger wire can be left floating from the RG-6 shield, but can be optionally connected to the shield of the F connectors on the end termination units with a 3/8" ID lug and nut.

Flooded, self-sealing RG-6 is an advantage for BOG configurations and buried feed lines back to the shelf. Small animals may chew through the outer jacket. Flooded RG-6 will seal the openings, preventing water from getting into the coax.

**14. *What effect does my local ground conductivity have on antenna performance, and should I make any adjustments to the height above ground to compensate for this?***

When mounted at least 7 ft. above ground level, electromagnetic modeling of the BevFlex-4X antenna shows little effect on the antenna's performance over a range of soil conductivities between 0.1 mS/m and 50 mS/m, which are typically found in most locations.

**15. *How will weather conditions affect the performance of my antenna?***

No more so than with any other wire antenna installation. The reversible Beverage allows you to switch directions to reduce interference from atmospheric storms coming from predominantly one direction. In such cases, it is better than other antennas for receiving under high noise conditions.

**16. *Why are there ground connections on each of the end terminating units?***

The ground rods provide a connection between the custom reflection transformers at each end of the antenna and the ground under the antenna, which completes the circuit between the two ends of the antenna.

**17. *Will I need to use an external preamp with this antenna?***

Generally, no external pre-amplifier is required or desired as signal levels from the BevFlex-4X are well above the noise floor of your receiver on frequencies below 10 MHz. Received signals from the BevFlex-4X will almost always be LOWER in "S" meter readings than on your transmit antenna, but the overall signal to noise ratio will be higher. An antenna pre-amplifier may be helpful for a BevFlex-4X configured as a Beverage-On-Ground (BOG) or EWE at frequencies above 7.0 MHz.

**18. *What kind of connector is required to interface with my radio?***

The output from the switching and termination unit is via a standard "F" connector matched to the 50 Ohm input impedance found on most receivers. You will need to provide a 50 Ohm cable and the adapters required to connect to your particular radio. ("F" to BNC, PL-259, RCA phono, etc.)

**19. Do I need to use 50 ohm cable between the switching unit and my radio?**

With the short lengths of cable involved in most installations, either 50 Ohm or 75 Ohm coaxial cable can be used.

**20. What is the minimum distance that I need to maintain between my transmit antenna and the closest point of the Beverage?**

The further, the better, as noise can be re-radiated from the transmit antenna into the BevFlex-4X. Typically, 50 ft. spacing is sufficient. It is important to locate the BevFlex-4X away from vertical transmit antenna systems, including the ground or elevated radial wires. If possible, route the BevFlex-4X antenna wire perpendicular to any other nearby antenna wires to minimize the coupling between the antennas. If it is not possible to provide this spacing, a relay can be used to open the connection (float) the transmit antenna while receiving. If high power is applied to a nearby transmit antenna, it is possible that the receiver protection, voltage limiting devices, in the Switching and Terminator Units could be damaged.

**21. Are the outdoor units weather proof?**

YES, but it is the installer's responsibility to use properly installed, weatherproof, connectors and seal the connections. It is important to mount the units with the feedline connectors pointing down and use drip loops on cables and wires approaching the boxes from the side or above to reduce the chance of moisture entering the connectors or the BevFlex-4X units.

**22. Do you have any weather proofing and installation tips?**

- Use plastic electrical tape to tape over the seams where the box and lid come together on the various units
- Be sure to allow a generous amount of coax center conductor protruding from the F connectors when you install them. This will allow for contraction of the center conductor during cold weather.
- Coat the center conductor with WD-40 or contact cleaner to maintain a good connection and prevent corrosion
- Use Vaseline or silicon grease on the threads of the F connectors when you put them together
- All wires and coax cable from the outside boxes must drop down away from their connection points to direct water away from the connection. If the wire or coax approaches from the side or top, form a drip loop before making the connection.
- Place a bead of RTV silicon rubber around where each F connector penetrates the various unit boxes. You can also use "liquid tape" for this purpose.
- Use copper clad steel ground rods. You can also use scrap, copper, water pipe if the ground is soft.
- Use bronze or stainless steel clamps to make connections to the ground rods
- If you hang an above ground Beverage hung from trees, etc., use plastic electric fence insulators with loose ty-raps to hang the RG-6 coax, but also let it slide as the supports move in the wind

**23. What kind of lightning protection is provided?**

Each end termination unit is protected by a gas discharge tube to reduce the possibility of damage from nearby static discharges. Use of a dual, F, connector grounding block is recommended for the feedlines entering the ham shack. None of these will prevent damage from a direct or near lightning hit.

**24. What is the minimum length needed for the Beverage antenna?**

Please review the chart in the application information for each antenna configuration. In general, the longer the better, with a practical minimum length being approximately 150 ft. While lengths greater than 1000 ft. can improve the gain of the antenna, the F/B ratio may suffer when the antenna is longer than (2) wavelengths at the desired reception frequency. There are many on-line references that discuss this trade-off in length.

**25. I only have 270 ft. available. Should I configure the BevFlex-4X as an above ground Beverage antenna or as a Beverage-On-Ground (BOG)?**

We have experience with a 270 ft. above ground, Beverage antenna and were pleasantly surprised by how well it worked even on 160m. We also have experience with a 175 ft. BOG on rocky soil and were impressed by how well it worked on 160m and 80m. This short BOG was able to achieve a 20dB front to back ratio on an AM broadcast station 40 mi away on 1600 KHz. If you want a high front to back ratio on 160m with a short antenna, we would recommend the BOG configuration with a length of 225'. We were frequently able to receive DX stations on either of these antennas that could not be copied on the transmitting antenna. Even with the BOG configuration, you will generally not need a pre-amplifier on 160m and 80m since the atmospheric noise level is still higher than the noise figure of a modern receiver.

**26. I have less than 50 ft. available. Can I still build an effective, receiving antenna with the BevFlex-4X?**

Yes, we have experience with EWE and FLAG antenna configurations as short as 25 ft. Although the gain is lower than a Beverage or BOG antenna, the EWE or FLAG antennas can still provide a low noise receiving capability with good front to back directivity. We have experience working stations that could not be heard on a dipole transmitting antenna using a 25 ft. EWE antenna for receiving. The VE3DO is another, slightly larger (40 ft.), antenna for restricted space applications.

**27. Can I have two BevFlex-4X antennas installed at right angles to each other to get optimum reception from (4) different directions?**

Yes, you can install multiple BevFlex-4X antennas that cross each other as long as the antenna wires cross at close to a 90 degree angle to each other and are separated by at least 12 inches. This spacing and orientation will minimize the coupling and interaction between the two antennas. The Unified Microsystems model RAS-4 optional antenna switch was designed to make a (4) direction Beverage system easy to build.

**28. Can I feed more than one receiver from my BevFlex-4X antenna system?**

Yes, you can use any standard 50 or 75 Ohm, isolated port, signal splitter that works down to your frequency band of interest to feed multiple receivers. The splitter would normally be placed after the direction switching unit. You can also split the forward and reverse feedlines from the antenna coupling unit into multiple feeds ahead of the directional switching unit. Switching ahead of the BevFlex-4X Switch Unit will require separate termination of unselected lines with a 75 Ohm resistor.

**29. How long can the feedline cables be from my shack to the Feed Unit?**

Insertion loss measurements of coaxial cable with either solid copper or copper plated steel center conductors confirm that the losses of RG-6 coaxial cable are very low at HF frequencies. Feed cables up to 1000 feet should not be an issue. Dual RG-6 "Siamese" pair type cable is very convenient for the feedlines from the antenna feed-point to the operating position. The feedline cables do not have to be equal in length.

**30. Do the A/B feedline cable lengths need to be matched in length?**

No, the cables do not have to be length or phase matched for any of the four configurations to work properly.

**31. Why is coaxial cable better than open wire, window/ladder line, or "twisted pair wire" for the antenna?**

The use of well shielded RG-6 coaxial cable provides better isolation between the common mode received signal on the outer surface of the shield and the differential mode signal inside the coaxial transmission line. The characteristic

impedance ( $Z_0$ ) of the coaxial transmission line is not affected by the external environment as much as the ( $Z_0$ ) of unshielded, parallel conductor transmission lines. Light weight, RG-6, coaxial cable is generally less expensive, easier to hang, and maintain than window/ladder line.

**32. Why are the coaxial feedline connections reversed for the EWE, FLAG, and VE3DO antenna system configurations?**

The EWE, FLAG, and VE3DO antenna configurations operate with the received signal transformer at the end of the antenna wire toward the direction of reception. The Beverage and BOG antenna configurations operate with the received signal transformer at the end of the antenna wire away from the direction of reception. The EWE, FLAG, and VE3DO configurations operate as a pair of top coupled, phased, vertical antennas while the Beverage and BOG configurations operate as resistively terminated traveling wave antennas.

**33. How do I measure the impedance or resistance of the various components of the system when troubleshooting?**

The end termination units and the feed-point unit all utilize RF isolation transformers between the various segments of coaxial transmission lines. Resistive measurements with an Ohm meter are of little value other than determining if there is a broken connection. The DC resistance measured across either of the feedlines to the shack will be a low value equal to the DC resistance of the coaxial cable in series with the DC resistance of the transformer in the feed-point unit. The DC resistance measured across either end of the coax used as the antenna will be a low value equal to the DC resistance of the coaxial cable in series with the DC resistance of the transformer in the end Terminator Unit.

You can use an Ohm meter to verify the terminating resistor values in the control box. This is done by measuring the resistance across the A or B inputs to the control box. The A input should measure 75 Ohms with the switch in the Forward position. The B input should measure 75 Ohms with the switch in the Reverse position. The only way to accurately measure the rest of the components of the system is to use an RF antenna analyzer to determine the actual RF impedances of the parts of the system you are troubleshooting.

**34. What can an RF antenna analyzer tell me about the operation of my BevFlex-4X?**

If all the connections are intact, and the correct impedance taps are selected on the end termination units, you should see a VSWR of typically less than 2:1 (referenced to 50 Ohms) across a frequency band from 1.8MHz to 10.0 MHz when you look into the "TO RX" connector of the control box with an antenna analyzer. As the frequency is swept across this range of frequencies, there should not be a large variation in the VSWR reading

**35. I want to avoid running multiple pairs of coaxial cables to my operating position. Can I control multiple BevFlex-4X antennas from a single control box?**

Yes, you can use a remote coaxial cable switch. The Unified Microsystems model RAS-4 switch was designed specifically for this application. Other companies also offer antenna switches, including DX Engineering, MFJ, etc., but they may require modification.

For proper operation, the unused direction coax must be terminated with a 75 ohm non-inductive resistor. The Unified Microsystems RAS-4 switch has built-in terminations. Most commercial antenna switches made for transmitting either leave unused ports open or short them to ground. Some switches designed for Beverage antennas terminate unused ports. You will have to determine if the switch you plan to use provides proper 75 ohm termination, and make modifications as necessary.

Coaxial switches that isolate the shields of the connecting cables are preferred. Most commercial coax switches use connectors mounted in metal cases, shorting the outer connections together. Shorting the shields from multiple

receive antennas may introduce common mode noise. Multiple loops of the coax through a large, low frequency, ferrite toroid at the switch may resolve this problem. The Unified Microsystems RAS-4 switch provides isolation between the shields of the different receive antennas.

You can also make your own remote switch by mounting DPDT switches in a water tight case. eBay and Amazon.com sell very inexpensive DPDT relays mounted on circuit boards with screw type terminals that will work well.

There is no requirement that all of the BevFlex-4X antenna configurations be Beverage or any other type of bi-directional antenna. Beverage antennas can be switched with BOG, EWE, FLAG, or VE3DO antennas as long as the correct antenna impedance taps are selected on the end termination units for each of the antennas.

**36. *Is there a simple way to check the Front to Back Ratio (F/B) of my BevFlex-4X?***

Yes, a good way to check the front to back ratio of the antenna is to find an AM broadcast band radio station that is more than 20 miles away in the direction your antenna is pointed. This test is best done in the daytime with groundwave propagation that provides a stable signal and not skywave propagation. You should see a significant F/B when you flip the switch on the control unit.

**Enjoy your BevFlex-4X antenna system. Now that you can hear them, you can now work them!**

**73 & good DX!**

**The BevFlex-4X Team**